

Matrix Series Matrix 400/200 400W/200W LED Grow Light

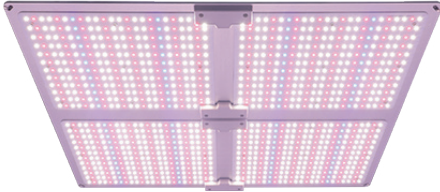

Matrix 400



Matrix 200

1 Introduction

Thank you for purchasing the Matrix Series LED grow lights. The Matrix Series LEDs are intended to be used in indoor grow rooms and indoor grow tents.

This manual describes the installation and connection of the product and also describes how to use the product. Mounting and installing of the Matrix Series LEDs may only be executed by certified service personnel. Please read and understand this manual completely before using the product. Only use the product as specified in this manual.

2 Product Information & Specifications

2.1 General Information

Matrix 400

Product Name	Matrix 400 400W LED Grow Light			
Manufacturer	Shenzhen VANQ Technology Co., Ltd.			
Version	US	EU	UK	AUS
Part Number	Matrix 400 -US	Matrix 400 -EU	Matrix 400 -UK	Matrix 400 -AUS
Plug Type	US plug 120-277V	EU plug 230V	UK plug 240V	AUS/NZS plug 240V
Input Voltage	120-277VAC	100-230VAC	100-240VAC	100-240VAC

Matrix 200

Product Name	Matrix 200 200W LED Grow Light			
Manufacturer	Shenzhen VANQ Technology Co., Ltd.			
Version	US	EU	UK	AUS
Part Number	Matrix 200-US	Matrix 200-EU	Matrix 200-UK	Matrix 200-AUS
Plug Type	US plug 120-277V	EU plug 230V	UK plug 240V	AUS/NZS plug 240V
Input Voltage	120-277VAC	100-230VAC	100-240VAC	100-240VAC

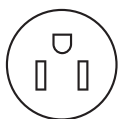

US 5-15P

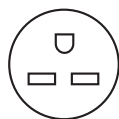

US 6-15P



US L7-15P

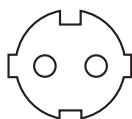

EU plug 230V

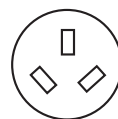

UK plug 240V

AUS/NZS
plug 240V

! **Note:** Other types of plug are also available, please check with our sales engineers directly.

2.2 Technical specifications

Product Model	Matrix 400	Matrix 200
AC Input Power	400W @ 240VAC	200W @ 240VAC
Light Output PPF	1080 $\mu\text{mol/s}$	540 $\mu\text{mol/s}$
Product weight	8.25 kg	4.15 kg
Dimensions	600mm L x 480mm W x 56mm D 23.62in L x 19.8in W x 2.2in D	600mm L x 240mm W x 56mm D 23.62in L x 9.45in W x 2.2in D
Efficacy	2.7 $\mu\text{mol/J}$	
AC Input Voltage	120-277V AC, 50/60Hz	
Spectrum	FSC, Full Spectrum	
Working temperature	-20°C ~ 40°C -4°F ~ 104°F	
Light Distribution	120°	
Dimming	0-10V	
IP Rating	IP65	
Certification standards	CE	

NOMINAL ELECTRICAL AC INPUT

Matrix 400

AC Voltage	120V	208V	230V	277V
AC Current	3.37A	1.94A	1.74A	1.44A
AC Power	404W	403W	401W	400W
Power Factor	0.98	0.98	0.98	0.98

Matrix 200

AC Voltage	120V	208V	230V	277V
AC Current	1.71A	0.97A	0.87A	0.72A
AC Power	205W	202W	201W	199W
Power Factor	0.98	0.98	0.98	0.98

2.3 Compatible products and accessories

Product	Product Name	Part Number
Controller	0-10V dimming controller	MG-VD100
Power cord	Power cord with US plug 5-15P, 1.5m/5ft	MG-PC-US515
	Power cord with US plug 6-15P, 1.5m/5ft	MG-PC-US615
	Power cord with US plug L7-15P, 1.5m/5ft	MG-PC-USL715
	Power cord with EU plug 230V, 1.5m/5ft	MG-PC-EU230
	Power cord with UK plug 240V, 1.5m/5ft	MG-PC-UK240
	Power cord with AUS/NZS plug 240V, 1.5m/5ft	MG-PC-AU240
Dimming cables	T-shape daisy chain connection dimming cable, 2m/6.5ft	MG-DCC-T01
Light Hanger	1/8" Adjustable Ratchet Hangers 1.8m/6ft (Set of 2 - Holds 150 lbs/100Kg)	MG-RH-01
	Steel Wire Rope Hanger 30cm/1ft (Set of 4 - Holds 150 lbs/100Kg)	MG-WR-01

2.4 Environment

The product is intended to be used in indoor growing environments. The product can be used in wet environments.

The product may not be used outdoors. The Matrix Series LEDs light functions optimal when the max ambient temperature is between 20~40°C.

2.5 Legal

CE LVD approval according to: EN 60598-2-1&EN 62471&EN 62493&EN 62778

CE EMC approval according to: EN 55015&EN 61547&EN 61000-3-2/-3

3 Packing List

Please follow the content of the list and carefully check whether the purchased equipment and accessories are complete. If you find that the actual product does not match the list, or the product is damaged, please contact us immediately and provide photos or videos!

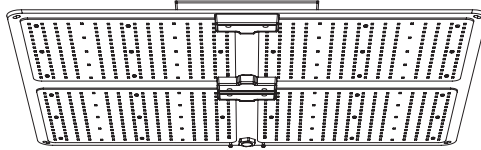

1.Matrix 400 X 1



2.Steel Wire
Rope Hanger X 2



3.1/8" Adjustable
Ratchet Hangers X 2



4.Power Cord X 1



5.Dimming Cable
(optional) X 1



6.VD-100 Controller
(optional, buy
separately) X 1

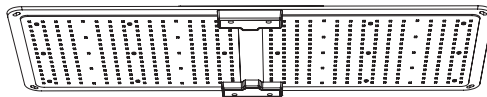

1.Matrix 200 X 1



2.Steel Wire
Rope Hanger X 2



3.1/8" Adjustable
Ratchet Hangers X 2



4.Power Cord X 1



5.Dimming Cable
(optional) X 1

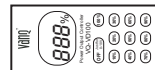











6.VD-100 Controller
(optional, buy
separately) X 1

No.	Product Name	Model	Quantity
1	Matrix 400/200	400W/200W	1
2	Steel Wire Rope Hanger	30cm/1ft	2
3	1/8" Adjustable Ratchet Hangers	1.8m/6ft	2
4	Power Cord	1.5m	1
5	Dimming Cable(optional)	T-Shape	1
6	VD-100 Controller(optional, buy separately)	0-10V Dimming	1

4 Safety Precautions & Warnings

Warning!

Carefully read the warnings below before using or working with the product!

-  Always adhere to the local rules and regulations when installing or using the LED light.
-  DO NOT connect to live power until installation is complete.
-  Do not open or disassemble the LED light. Opening or modifying the LED light can be dangerous and will void the warranty.
-  Do not use the LED light when either the LED light or its power cord are damaged. Replace the power cord only with original certified cords.
-  Modifications to the cords can lead to unwanted electromagnetic effects, which makes the product not comply with legal requirements.
-  Do not expose the LED light to:
 - (ambient) temperatures outside the specified range;
 - dust and contamination;
 - direct sunlight during use or HID light that could heat up the ballast.
-  Always disconnect the LED light from mains before performing any maintenance.
-  Always allow for a cool down period of at least 30 minutes before touching the LED bars. Touching the LED bars when the light is lit or immediately afterwards can result in severe burns!
-  Do not use the LED light near flammable, explosive or reactive substances. Do not use sulfur vaporizers or water misters.
-  The installation and use of the LED light is the responsibility of the end user. Incorrect use or installation can lead to failure and damage to the LED light. Damage to the LED light and electronic circuitry as a result of incorrect installation and use revokes the warranty.

5 Installation

Warning!

- ⚠ Mounting and installing of the LED light may only be executed by certified service personnel, in accordance with the applicable local laws and regulations.
- ⚠ The installer is responsible for correct and safe installation.
- ⚠ Ensure the local cabling can support the voltage and current requirements of the LED light.
- ⚠ Avoid coiled cords and keep mains leads separated. This prevents electromagnetic interference.
- ⚠ Do not connect or disconnect the LED light under load.
- ⚠ Mount the system to something that can hold the weight of the LED light.

5.1 Hanging the LED light to mounting system

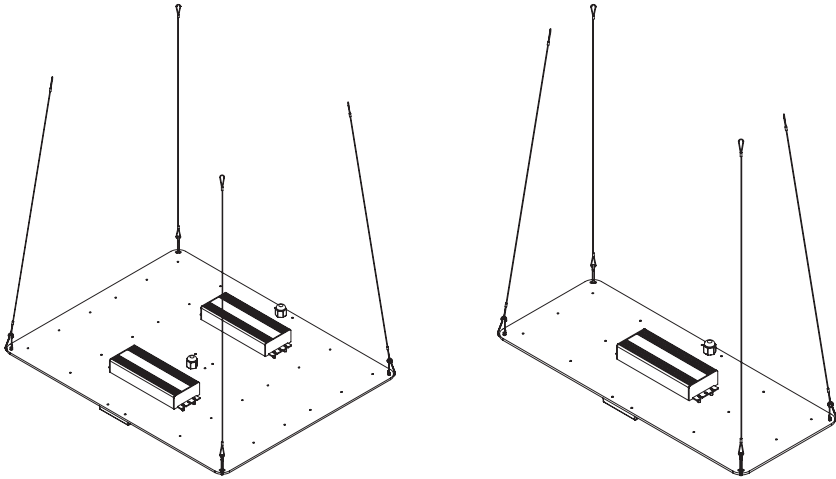

The suggested height from the plant canopy to the LED light is:

During vegetative stage, 1ft - 1.5ft/30cm - 45cm

During flowering stage, 0.6ft - 1ft/15cm - 30cm

Below is the PPF map of Matrix 400/200 at 3 different hanging heights.

Matrix 400

Hanging Height: 12" (30cm)

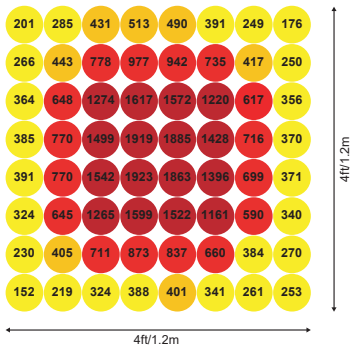

Average PPFD of 4ft x 4ft footprint: 738 $\mu\text{mol}/\text{m}^2/\text{s}$

Matrix 200

Hanging Height: 12" (30cm)

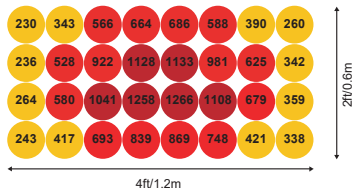

Average PPFD of 4ft x 2ft footprint: 648 $\mu\text{mol}/\text{m}^2/\text{s}$

Hanging Height: 18" (45cm)

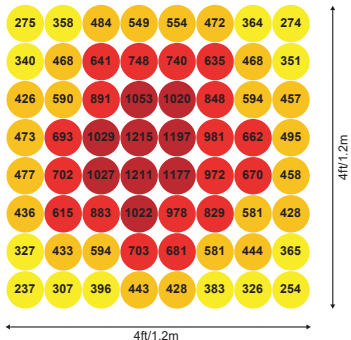

Average PPFD of 4ft x 4ft footprint: 620 $\mu\text{mol}/\text{m}^2/\text{s}$

Hanging Height: 18" (45cm)

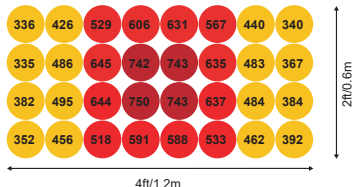

Average PPFD of 4ft x 2ft footprint: 522 $\mu\text{mol}/\text{m}^2/\text{s}$

Hanging Height: 24" (60cm)

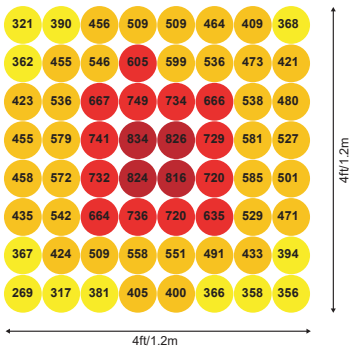

Average PPFD of 4ft x 4ft footprint: 531 $\mu\text{mol}/\text{m}^2/\text{s}$

Hanging Height: 24" (60cm)

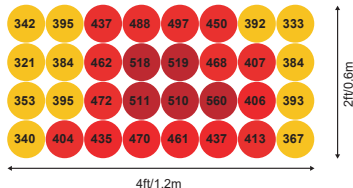

Average PPFD of 4ft x 2ft footprint: 429 $\mu\text{mol}/\text{m}^2/\text{s}$

5.2 Connecting the LED light to the mains

Warning!

- ⚠ Make sure mains power is switched off.
- ⚠ Ensure the cord is not coiled and does not touch any hot surfaces.
- ⚠ Connect the cables according to local rules, safety regulations and electrical code.
- ⚠ Ensure external switching gear can cope with the inrush current of the LED fixture. Always use a double pole contactor suitable for switching a capacitive load. Never use household timers to switch the LED fixture!

6 Connecting Matrix 400/200 lights To A Controller

Warning!

- ⚠ Do not connect or disconnect the controller with LED light under load.
- ⚠ Ensure the power cord and the controller cables do not touch any of the LED bars.

Using a daisy chain setup, a maximum of 50pcs Matrix 400/200 LED lights can be connected to one controller. The controller can dim the Matrix 400/200 LED light from 0 to 100%.

- Connect the dimming cable to the dimming port on the first Matrix 400/200 light.
- Use dimming cable (T-shape) to connect the dimming port of the following Matrix 400/200 light
- Repeat these steps to connect up to 50pcs Matrix 400/200 LED lights.

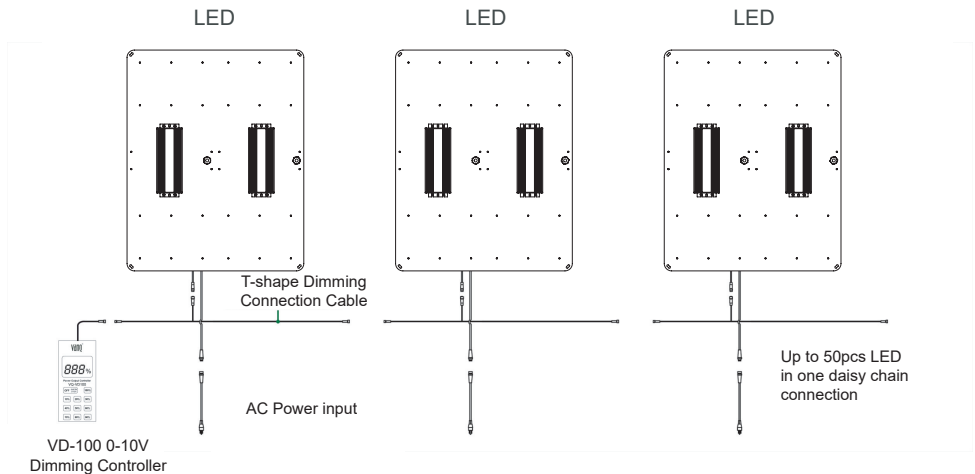

7 Inspection, maintenance and repair

- ⚠ Caution! Do not clean the LED fixture with detergents, abrasives or other aggressive substances.
 - Regularly check the LED fixture for dust or dirt buildup. Clean if necessary. Contamination may cause overheating and decreased performance. Clean the outside of the LED fixture using a dry or damp cloth.
 - Regularly check the cables of the LED fixture to ensure it is undamaged.

8 Storage and disposal

- Store the LED fixture in a dry and clean environment, with an ambient temperature of -20~85° C.
- The product must not be discarded as unsorted municipal waste, but must be collected separately for the purpose of treatment, recovery and environmentally sound disposal.

9 Warranty service

VANQ technology warrants the mechanical and electronic components of their product to be free of defects in material and workmanship if used under normal operating conditions for a period of three(3) years from the original date of purchase. If the product shows any defects within this period and that defect is not due to user error or improper use, VANQ technology shall, at its discretion, either replace or repair the product using suitable new or reconditioned products or parts. In case VANQ technology decides to replace the entire product, this limited warranty shall apply to the replacement product for the remaining initial warranty period, i.e. three(3) years from the date of purchase of the original product. For service, return the Matrix 400/200 light to your shop with the original sales receipt.