

VQ-VD Series Controller

Lighting Controller



1 Introduction

Thank you for purchasing VANQ Lighting Controller . It is intended to be used in horticulture lighting system.

This manual describes the installation and connection of the product and also describes how to use the product. Please read and understand this manual completely before using the product. Only use the product as specified in this manual.

2 Functions

- ① 0-10V single-channel dimming, 11 gears in total
- ② Memorize function of last setting
- ③ Matchable with all CC/CV 0-10V Dimmable Led Grow Light
- ④ Screen auto sleep if long time no operation to prevent false triggering
- ⑤ High precision power regulation
- ⑥ Timing dimming, dimming value can be set once within 24 hours
- ⑦ Default sunrise and sunset mode, gradually adjust to the set power 15 minutes before the timing Start or ends;

3 Product Information & Specifications

3.1 General Information

Product Name	VANQ Brand VD Series Controller		
Manufacturer	Shenzhen VANQ Technology Co., Ltd.		
Model No.	VD100-V1	VD100-V2	VD500
Power Plug Type	US/EU/UK/AU/JP	***	US/EU/UK/AU/JP
Dimming Connector Type	RJ11/RJ12/RJ19/RJ45 /M12	RJ11/RJ12/RJ19/RJ45 /M12	RJ11/RJ12/RJ19/RJ45 /M12
Input Voltage	AC100-240	0-10V	AC100-240

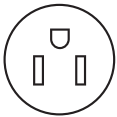

US 5-15P

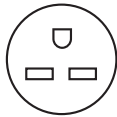

US 6-15P



US 7-15P

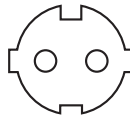

EU plug 230V

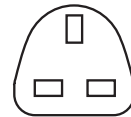



UK plug 240V



AUS/NZS
plug 240V

Note: Other types of plug are also available, please check with our sales engineers directly.

3.2 Compatible products and accessories

	VD100-V1	VD100-V2	VD500
Picture			
Weight	250g	200g	250g
Dimension	135*70*26mm	135*70*26mm	135*70*26mm
Power Cable Length	100CM	50CM	100CM
Dimming Cable Length	50CM	50CM	50CM
Input voltage	AC100-240 50/60Hz	0-10V	AC100-240 50/60Hz
Input Current	Max 1A	Max 1A	Max 1A
Output Accuracy	±3%	±3%	±3%
Max Connections	150 sets Drivers	150 sets Drivers	300 sets Drivers
Package Size	155*121*88MM	155*121*88MM	155*121*88MM







3.3 Environment

The product is intended to be used in indoor growing environments. The product can be used in wet environments. Working temperature is between -20°C ~ 40°C | -4°F ~ 104°F.



4 Safety Precautions & Warnings

Warning!

Carefully read the warnings below before using or working with the product!

-  DO NOT connect to live power until installation is complete.
-  Do not open or disassemble the controller. Opening or modifying can be dangerous and will void the warranty.
-  Do not use when its power cord or dimming cord are damaged. Please replace the cord only with original certified cords.
-  Modifications to the cords can lead to unwanted electromagnetic effects, which makes the product not comply with legal requirements.
-  Do not expose the controller to:
 - (ambient) temperatures outside the specified range;
 - dust and contamination;
-  Always disconnect the controller from LED before performing any maintenance.
-  Do not use the LED light near flammable, explosive or reactive substances. Do not use sulfur vaporizers or water misters.

Cautions!

-  If the dimming cable of the controller is disconnected, the brightness of the led will return to 100%. If only the adaptor of the controller is unplugged, the brightness of the led will be abnormal.
-  There are two power supply modes for this product. Please pay attention before purchasing, one is for the driver to supply power to the controller, and the other is equipped with an independent adaptor to supply power to the controller.

If you need different types of dimming cables to match your led, please contact our customer service, we can replace them for you.

5 How To Use

Connecting Controller to grow light as below instructions :

Using a daisy chain setup, a maximum lights can be connected to one controller.

The controller can dim the LED light from 0 to 100%.

- Connect the dimming cable to the dimming port on the first LED light.
- Use dimming cable (T-shape) to connect the dimming port of the following LED light.
- Repeat these steps to connect up to maximum connections.

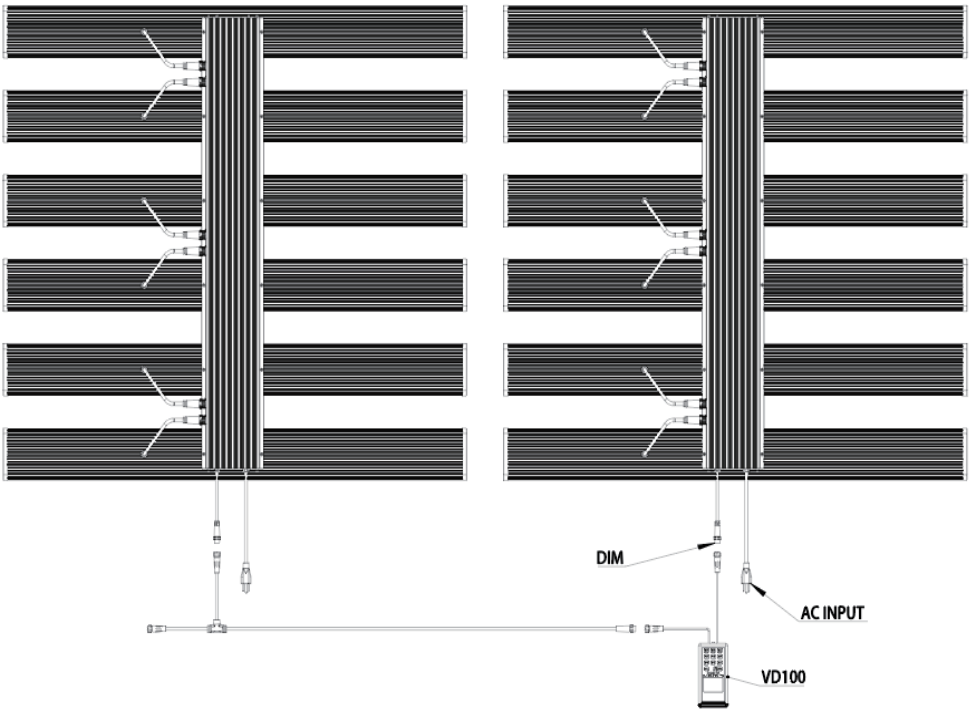

5.1 Manual dimming

Short press the "Dim" button, The dimming value will flash, press the up and down buttons to adjust the required dimming value, and finally press the "OK" key to confirm

5.2 Timing dimming

Short press the "Timer" button, The time value will flash, press the up and down buttons to adjust the required time, and press the left and right buttons to turn on or off the minutes and hours

5.3 Timer Turn on and turn off

When the turn-on time and turn-off time are the same or turn-on time is smaller than the turn-off time, the timer will automatically turn off, and no manual operation is required.

5.4 Set the system time

Long press the "Time set" button, The system time value will flash, press the up and down buttons to calibrate the time, and press the left and right buttons to switch between hours and minutes.

Warning!

- ⚠ Do not connect or disconnect the controller with LED light under load.
- ⚠ Ensure the power cord and the controller cables do not touch any of the LED bars.

Using a daisy chain setup, a maximum lights can be connected to one controller. The controller can dim the LED light from 0 to 100%.

- Connect the dimming cable to the dimming port on the first LED light.
- Use dimming cable (T-shape) to connect the dimming port of the following LED light.
- Repeat these steps to connect up to maximum connections.

6 Size & packaging

6.1 Size:



135mm L * 70 mm W * 26mm H

6.1 Packaging:

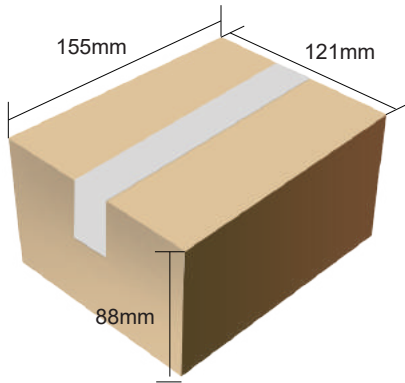

Packaging:

1 pcs / carton

Gross Wweight:

250g (VD-100 V1 / VD-500)

200g (VD-100 v1)

Size:

155mm L * 121mm W * 88mm H

7 Inspection, maintenance and repair

- ❗ Store the LED fixture in a dry and clean environment, with an ambient temperature of -20~85° C. The product must not be discarded as unsorted municipal waste, but must be collected separately for the purpose of treatment, recovery and environmentally sound disposal.

8 Storage and disposal

VANQ technology warrants the mechanical and electronic components of their product to be free of defects in material and workmanship if used under normal operating conditions for a period of five (3) years from the original date of purchase. If the product shows any defects within this period and that defect is not due to user error or improper use, VANQ technology shall, at its discretion, either replace or repair the product using suitable new or reconditioned products or parts. In case VANQ technology decides to replace the entire product, this limited warranty shall apply to the replacement product for the remaining initial warranty period, i.e. five (3) years from the date of purchase of the original product. For service, return the VD Series Controller to your shop with the Lighting Controller original sales receipt.

- ❗ The product must not be discarded as unsorted municipal waste, but must be collected separately for the purpose of treatment, recovery and environmentally sound disposal.

VANQ VD Series

Lighting Controller

Changes reserved - Version 01/22

Manufacturer

Shenzhen VANQ Technology Co., Ltd.

3#, BLDG B, Debaoli Industrial park, NO.312, Jihua Road

Bantian, Longgang, Shenzhen, Guangdong China

T. + 86 755 2904 2099

F. + 86 755 2904 2092

E. vanqled@vanqled.com

W. www.vanqled.com